

Thesis and Dissertation Guidelines



School of Graduate Studies

Alabama A&M University

Normal, Alabama 35762

2012 - 2013

*Copyrights are reserved. This document may not be
copied without the written consent of the School of
Graduate Studies, Alabama A&M University.
June 2012*

*Dr. Vann Newkirk, PhD.
Associate Provost and Dean of Graduate Studies
Alabama Agriculture and Mechanical University
Normal, Alabama 35762*

Table of Contents

Preface	i
Chapter One Introduction	1
<i>What Function Does this Manual Serve?</i>	1
<i>Ethical Responsibilities of the Graduate Candidate</i>	1
Chapter Two The Thesis or Dissertation Proposal	3
Selecting your Research Area, Major Professor, and Advisory Committee	3
The Elements of a Thesis or Dissertation	4
<i>Introduction</i>	4
<i>Statement of the Problem</i>	4
<i>The Purpose or Objectives of the Study</i>	4
<i>Review of the Literature</i>	4
<i>Design or Methodology of the Study</i>	5
<i>References</i>	5
<i>Styles of Writing</i>	6
<i>World Wide Web Citations</i>	7
Chapter Three The Thesis or Dissertation Requirements	8
<i>Submitting the Thesis or Dissertation to the Advisory Committee</i>	8
<i>Submitting the Thesis or Dissertation to the Graduate School</i>	8
<i>Requesting a Thesis or Dissertation Defense</i>	8
<i>Deposit of Final Copies</i>	9
Format for the Thesis or Dissertation	9
<i>Paper Requirements and Fonts</i>	9
<i>Margins</i>	10
<i>Pagination</i>	11
<i>Numbering Tables, Figures, and Appendices</i>	11
Parts of the Thesis or Dissertation	12
<i>Order of the Thesis or Dissertation</i>	12
<i>Fly Page</i>	12
<i>Title Page</i>	12
<i>Certificate of Approval</i>	13
<i>Copyright Page</i>	13
<i>Dedication (Optional)</i>	13
<i>Abstract and Key Words</i>	13
<i>Table of Contents</i>	14
<i>List of Tables</i>	15
<i>List of Figures</i>	15
<i>List of Plates</i>	15
<i>List of Symbols, Abbreviations and/or Specialized Nomenclature</i>	15
<i>Acknowledgments (Optional)</i>	16

The Text	16
<i>Introduction</i>	16
<i>The Body of the Thesis</i>	16
<i>Chapter or Section Headings</i>	17
<i>First Order Subdivision</i>	17
<i>Second Order Subdivision</i>	17
<i>Third Order Subdivision</i>	17
<i>Equations</i>	18
<i>Footnotes and Endnotes</i>	18
<i>Photographs</i>	18
<i>Preparation of Tables</i>	19
<i>Preparation of Figures</i>	20
<i>Appendices (Optional)</i>	21
<i>References</i>	21
<i>Fly Page</i>	21
Chapter Four The Thesis or Dissertation Defense	22
<i>Awareness of the Professional Setting</i>	22
<i>What is the Typical Scenario for the Defense</i>	23
Chapter Five Electronic Thesis & Dissertation Procedures.....	27
Electronic Thesis and Dissertation Process (ETD) at Alabama A&M University	27
Benefits of Preparing an ETD	27
Submission of the ETD	28
Final Electronic Copy	30

Appendices

A. Suggested References to Aid the Student in Writing	31
<i>Spelling</i>	31
<i>Elements of Style such as Grammar, Punctuation, and Usage</i>	31
B. Sample Milestone Chart for the Thesis or Dissertation Proposal	32
C. Signature Page for the Oral Examination of the Thesis or Dissertation	33
D. Sample Title Page for the Thesis or Dissertation	34
E. Sample Certificate of Approval for the Thesis or Dissertation	35
F. Sample Copyright Page for the Thesis or Dissertation	36
G. Sample Dedication for the Thesis or Dissertation	37
H. Sample Abstract and Key Words for the Thesis or Dissertation	38
I. Two Sample Formats for the Table of Contents	39
J. Sample List of Tables for the Thesis or Dissertation	40
K. Sample List of Figures for the Thesis or Dissertation	41
L. Sample List of Abbreviations for the Thesis or Dissertation	42
M. Sample Acknowledgments for the Thesis or Dissertation	43
N. Sample Beginning Page of a Chapter for the Thesis or Dissertation	44
O. Sample Page Containing Equations for the Thesis or Dissertation.....	46
P. Sample Table Showing Vertical Placement	47
Q. Sample Table Showing Horizontal Placement	48
R. Sample Page Showing Table Integrated into the Text	49
S. Sample Showing How to Handle a Table Continued to the Next Page	50
T. Techniques for Folding Oversized Pages in the Thesis or Dissertation	51
U. Sample Figure with Subtending Caption	52

V. Sample Horizontal Figure with Opposing Caption Page 53
W. Sample Page Showing Figure Integrated into the Text 54
X. Sample Appendix Page for the Thesis or Dissertation 55
Y. Sample Bibliography Page for the Thesis or Dissertation 56
Z. Sample Vita for the Thesis or Dissertation 57

Index 58

Preface

A thesis or dissertation is an important scholarly achievement: its completion in the best possible form is a matter of tangible pride to the candidate. Since it is a by-product of the student's work completed at Alabama A&M University, it should reflect credit on the University, the Graduate School, and the department from which the candidate came. These guidelines were developed with the objective of simplifying the format standards to allow maximum flexibility to individual departments and disciplines while retaining a degree of uniformity among the thesis and dissertation documents produced. These guidelines are the result of an amalgam of input from many different sources.

Although students may study deposit copies of existing theses or dissertations, they should not use previously submitted and approved theses or dissertations as a basic guide for preparation of a current one. Current standards and guidelines for preparation of a thesis or dissertation may not be reflected in the previously accepted works which were based on prior Graduate School policies and editions of the guidelines.

As a graduate student at Alabama A&M University, you are writing a thesis or dissertation in partial fulfillment of the requirements for an advanced degree. If there are conflicts between the styles or requirements set forth in this manual and those in your discipline's journals or department guidelines, the current thesis and dissertation guidelines manual takes precedence. If you have any questions concerning format requirements, do not hesitate to contact the Graduate Office.

What Function Does This Manual Serve?

The completion of a thesis, field report, or dissertation is part of the requirements for an advanced degree. The purpose of this manual is to serve as a guide for the preparation of field research reports, theses, and dissertations as set forth by the School of Graduate Studies. The conventions and rules described within these guidelines ensure that a theses and dissertations produced will have uniformity with respect to their general appearance, the quality of paper, margins, and sequences of sections within the document. A major effort has been made to simplify this manual to maximize its applicability across disciplines and to improve its usefulness to the candidate, major professor and members of the committee. Additional sources of information that provide help to the student in the use of correct grammar and style are listed in Appendix A.

Where can I find help?

Ethical Responsibilities of the Graduate Candidate

The writing of a thesis or a dissertation is a scholarly achievement that reflects not only the depth of knowledge of the candidate but also the candidate's professional integrity. Particular care must be exercised to properly acknowledge cited works and copyrighted materials.

What is plagiarism?

Plagiarism is a severe ethical violation and can be grounds for dismissal from Academic Study At Alabama A&M University.

When a writer uses the ideas or words of others, the source of those ideas must be cited. Plagiarism is copying the language, structure, idea, and/or thoughts of another and passing them off as one's own original work.

When the student submits the proposal for format approval, the student is asserting that his or her work is original and has not been plagiarized in any form. Furthermore, by signing the student's cover page, the members of the Advisory Committee are in effect stating that they believe the student's work is original and that the integrity of the University has been maintained. Penalties for plagiarism, a serious academic offense, are specified in the Graduate School Catalog.

Must I get permission to use copyrighted material?

If a student elects to make extensive use of copyrighted material, the permission of the owner of the copyrighted material must be obtained. If the copyrighted material used is only a very small proportion of the total work, for example, a few lines out of an entire novel, then generally permission need not be obtained. If the material represents a significant proportion of the finished work, permission must be obtained. Material intended to be consumable such as survey forms, tests, exercises or handouts used for teaching, etc. may not be used without permission. Once permission has been obtained, it should be reported in the acknowledgments and the source of the material should be cited.

The finished thesis or dissertation is a reflection of the abilities of the graduate student, his or her major professor, and the Advisory Committee and affects the reputation of the University. It should be of the highest ethical caliber and the best quality that the student can produce.

The Thesis or Dissertation Proposal

2

Selecting your Research Area, Major Professor, and Advisory Committee

Selecting the Major Professor and the members of the Advisory Committee

The major professor is typically assigned by the Department Chairperson based upon the research interests of the student and the willingness of the professor to serve as the chairperson of the student's Advisory Committee. The student and major professor jointly select the other members to serve on the Research Advisory Committee. The committee usually consists of 4-5 members, one of whom comes from outside the student's department. Persons selected as outside evaluators must be of high caliber and should be recognized as an expert in their field of study. Once the members of the Advisory Committee have been selected and approved by the Graduate Dean, they will serve as advisors for the candidate in the development of the research proposal.

When is the thesis or dissertation proposal due?

The School of Graduate Studies recognizes that the research proposal is at best a tentative plan of approach to a thesis or dissertation problem. It should represent a well thought-out approach that can serve as a guide. However, the research proposal is also not intended to be as extensive as the final thesis or dissertation. It should be concise to the point since its role is to serve as a guiding framework for the research itself. Under no conditions should the student expect to submit the proposal and then graduate within the same semester. The proposal is intended to be submitted at least one semester before the majority of the research is completed.

*What are the parts
of a thesis or
dissertation
proposal?*

The Elements of a Thesis or Dissertation

Introduction

The introduction should contain a general introductory statement indicating why the study is important and the state of the problem. Suitable background information may be incorporated into the introductory statement if it is relevant.

Statement of the Problem

This statement should consist of a clear and sharply focused delineation of the problem, culminated by formal problem statements, usually written in the form of research questions.

*The purpose of the
study should be
clear and concise.*

The Purpose and Objectives of the Study

The specific objectives of the study must be clearly stated and unambiguous, containing sufficient detail to serve as a specific guide to the research.

Review of the Literature

In this section, students must demonstrate knowledge of the relevant research related to the proposed research. The literature review is not a mere recitation of results of other studies, but a logical and coherent synthesis of results in a thematic manner that supports the research hypothesis (es).

Design or Methodology of the Study

This section includes designation of the research methods and techniques that will be used, the parameters which must be measured to test the hypotheses or answer the questions asked in the problem analysis, the sources of such data, and the techniques used to gather and analyze the data. Description of tools and techniques for collecting data should include descriptions of an experimental design, and the section that describes techniques for analyzing data should identify statistical techniques and sources. A graphical milestone chart or time schedule should be included. A sample milestone chart is shown in Appendix B. A milestone chart is an itemized listing of the approximate time required to complete each major step (or milestone) of the proposed research plan. The graduate student should indicate when he or she anticipates completing the research. A milestone chart is a very useful tool for planning and sequencing the major events which must occur to conduct the planned research successfully.

References

All relevant articles, books, or other sources that were used in the preparation of the thesis or dissertation must be cited. In preparation of this section students must use an appropriate style (as identified by their department of study) for listing the sources (see styles of writing below and in Appendix A). It is critical that students consistently use the style identified by their department of study throughout the entire thesis or dissertation. When you submit your thesis for format evaluation, the advisor will check carefully the format of your citations and the reference list (i.e., that every work cited in the text appears in the references), the order of references, and the completeness of entries. The first page of the references, like the first page of each chapter, is counted but not numbered.

Styles of Writing

All thesis and dissertation papers must conform to an accepted style manual which sets guidelines for references, tables, figures, margins, page numbering, quotations, etc. (Students completing thesis and dissertation papers should consult with their major advisor to determine the style used by their department).

- ❖ The thesis must conform to ONE style manual approved by the Graduate Schools. Currently, only MLA, APA, and Chicago styles are approved. Thesis and dissertation papers using more than one style will not be accepted and will be returned to the student.
- ❖ The following style manuals are available at most local bookstores:

Publication Manual of the American Psychological Association, (6th ed.) published by the American Psychological Association, Washington, D.C., 2010. APA is the style most frequently used in the sciences, engineering, and social sciences.

MLA Handbook for Writers of Research Papers, (7th ed.) published by the Modern Language Association, New York, 2009. MLA is used most frequently by Education, and Social Work majors.

The Chicago Manual of Style (16th ed.), published by the University of Chicago Press, Chicago, 2010. The Chicago Style is universal in application because of two referencing and citation systems.

World Wide Web Citations

Students in some cases may use sources in their research that include scholarly projects, reference databases, the texts of books, articles in periodicals, and professional and personal sites from the World Wide Web. Sources cited from the Web, like citation of printed work, must appear as an entry in the "Literature Cited," "References," or "Bibliography" and include the same information that would be provided for a printed source. An additional requirement, however, is retrieval information placed at the end of the reference. Retrieval information must include the date of retrieval because documents on the Web may change in content or site location. Guidelines for citing electronic resources located on the World Wide Web are available at the Reference Desk of the University Library. In addition, the site American Psychological Association provides detailed information on how to cite information from the World Wide Web, Email, Web discussions, Listserv messages, Newsgroup messages, Real-time communication, Telnet, FTP and gopher sites. The Modern Language Association of America provides information about documenting sources from the Internet. If citation questions arise that the Writing Center or the Web sites above do not address, consult your thesis advisor or the Graduate School.

Chapter 3 - The Thesis or Dissertation Requirements

Submitting the Thesis or Dissertation to the Advisory Committee

The first draft of the thesis or dissertation must be reviewed and approved by each member of the Advisory Committee prior to scheduling a thesis or dissertation defense. The Advisory Committee should receive the review copy no later than one month prior to the anticipated date for the thesis or dissertation defense. If the thesis or dissertation is found to be acceptable by all the members of the Advisory Committee and the major professor, a thesis defense may be requested using the form provided by the School of Graduate Studies.

Submitting the Thesis or Dissertation to the Graduate School

The Graduate School should receive the first draft of the thesis or dissertation at least six weeks before the anticipated date of the thesis dissertation defense. Permission to hold the thesis or dissertation defense will not be granted until all grammatical and format problems are removed from the thesis or dissertation (Please see chapter 5 for the thesis and dissertation submission process).

Requesting a Thesis or Dissertation Defense

Once the thesis has been approved, the student's advisor, in conjunction with the student, must request permission to hold the final examination using the form provided by the School of Graduate Studies. The examination must be scheduled at least four weeks before graduation. The student is responsible for checking the calendar for relevant deadlines for graduation for the semester in which he/she wishes to graduate. After the student's final oral defense, the members of the Advisory Committee shall sign a cover sheet indicating their approval or disapproval of the student's performance at the defense (Appendix C).

Deposit of Final Copies

After the student has passed the oral examination, and no later than two weeks before the stated deadline date for graduation an electronic copy and a hardcopy of the thesis or dissertation (see Chapter 5 for the thesis and dissertation and submission process) must be submitted to the Graduate School.

Paper Requirements and Fonts

Assuming the student has met all of the degree requirements, including paying all associated fees, the Graduate School will have one copy of the paper bound (The copy of the thesis or dissertation must be one sided on 8 1/2 x 11 inch, 25 pound white paper with 100% cotton lint content. The weight and content of the paper must be consistent throughout the thesis. All copies must be free of smudges or blemishes). Students who want to purchase a bound copy of the thesis should contact the Office of Graduate Studies for pricing and the process for purchasing additional copies.

What font type is appropriate to use?

The choice of the font type has a significant effect on the overall appearance of the finished thesis or dissertation. A 12 point book type font such as Helvetica, Palatino, or Times Roman should be used consistently throughout the document. The preliminary pages including the approval sheets, the text, tables, figure captions, page numbers, and appendices must all be in the same font for consistency. Parts of a figure may be in a different font. A smaller font size such as 10 point may be used in the tables if its use enables the positioning of a table onto one page. A 14 point font may be used for the chapter numbers and title. A larger font size such as 14 point may also be used to emphasize the title on the title page.

What is a widow?

Care should be taken to observe the customary rules about widows, orphans, and headers. A "widow" is part of a line from the end of a paragraph that is carried to the next page. Adjust the text to eliminate these. A header should not be put at the bottom of a page unless there is room for the header and at least two lines of text. If there is insufficient room, place the header on the next page.

Margins

What are my margins?

The margins for each page of the thesis or dissertation (preliminary pages, text, references) – must meet the following specifications, measured from the edge of the paper to the text:

left	1 1/2 inch
right	1 inch
top	1 inch
bottom	1 inch

This margin is inviolable. Footnotes, the last lines of a paragraph or a table, or the page number must be accommodated without violating the minimum margin of one inch of white space at the bottom.

Holes or perforations are not permitted in any of the margins. Some reproduction or photocopying processes magnify or spread the material which may necessitate more careful attention to the margin spacing's. The text may be either "justified" or "left justified" as long as it is used consistently throughout the entire thesis.

However, when using justify students are responsible for ensuring that the spacing between words and letters conform to the style guide selected by their department of study. Tabs should be used for a consistent offset at the beginning of each paragraph and must be of a uniform spacing (five spaces).

Pagination

How are the pages numbered?

The pages preceding chapter 1 must be numbered consecutively in lowercase Roman numerals. Starting with the title page and continuing throughout the thesis, each page must be accounted for and/or numbered. Although the title page is counted, a number is not placed on the title page itself. Fly pages are neither numbered nor counted. Numbers on all pages including the first page of every major division of the thesis or dissertation are placed one inch above the bottom edge of the sheet and centered. The table in the following section "Parts of a Thesis or Dissertation" contains a detailed listing of the parts of the thesis or dissertation and indicates whether each is counted or numbered and if numbered, what type of page number it receives.

Numbering Tables, Figures, and Appendices

How are the tables, figures, and appendices numbered?

Each table and figure used within the thesis must be given a unique number and a title. Arabic numbers are used for both tables and figures. Tables and figures are numbered independently of each other. A list of tables and a list of figures are placed separately in the preliminary pages of the thesis after the table of contents. Appendices are labeled alphabetically. Alternately, a numbering system reflecting the location or chapter within the thesis may be used for figures or tables(for example) Table 2.1, Table 2.2, Table 2.3, etc. for tables occurring in Chapter 2. Appendix figures or tables would follow the same pattern, Figure A.1, A.2, A.3, etc.

PARTS OF THE THESIS OR DISSERTATION

The table which follows gives the order in which the various parts of the thesis or dissertation should appear and indicates whether they are numbered and/or counted.

Order of Thesis or Dissertation

What is the order for the parts of the thesis?

Fly Page (Blank)	Uncounted	Unnumbered
Title Page	Counted	Unnumbered
Certificate of Approval	Counted	Small Roman Numeral, ii
Copyright Page	Counted	Small Roman Numeral, iii
Dedication (Optional)	Counted	Small Roman Numeral
Abstract and Key Words	Counted	Small Roman Numeral
Table of Contents	Counted	Small Roman Numeral
List of Tables	Counted	Small Roman Numeral
List of Figures	Counted	Small Roman Numeral
List of Plates (Optional)	Counted	Small Roman Numeral
List of Symbols, Abbreviations, Nomenclature, Definitions (Optional)	Counted	Small Roman Numeral
Acknowledgments (Optional)	Counted	Small Roman Numeral
Text	Counted	Begin Arabic Numeral 1, 2...
Appendix(es) (Optional)	Counted	Arabic Numerals
Bibliography	Counted	Arabic Numerals
Vita	Uncounted	Unnumbered
Fly Page (Blank)	Uncounted	Unnumbered

Fly Page

The fly page is a blank sheet of paper that contains no information. It is neither counted nor numbered.

Title Page

The wording and the format of the title page must be exactly as shown in Appendix D. The name of the student must appear in the same form as he or she is registered at the University. The date on the title page must indicate the month and year that the student will actually receive the degree.

The title serves as a guide for others who wish to gain more information about what has been done in your research. Modern search and retrieval systems use the words in the title and a few other key words that you have selected and identified below the abstract as KEY WORDS. Therefore, it is doubly important to select a title that is a meaningful and concise description of the contents of the thesis or dissertation.

Certificate of Approval

After all of the corrections recommended by the thesis or dissertation Advisory Committee and the Graduate Office have been made, a certificate of approval must be signed by each committee member and included in the thesis. (Approval sheets must contain the original signatures of the Advisory Committee.) The number of signature lines is equal to the number of members of the Advisory Committee. See Appendix E.

Copyright Page

A thesis or a dissertation may be protected from unauthorized copying by inserting a copyright page. The wording which appears on the copyright page can be seen in Appendix F. The student may also register this copyright with the Copyright Office, Library of Congress, Washington, D.C.

Dedication (Optional)

If a dedication is used, it should be centered on the page. The dedication should be brief (i.e. one or two lines) and no heading is necessary. See Appendix G for a sample dedication.

Abstract and Key Words

The abstract should contain a rationale or justification for the study. Generally, a brief account of the purpose, need, and significance of the investigation is given. The objectives must be clear and concise. A brief account of the methodology is given, particularly those parts that are unique. The results and principal conclusions are provided.

The abstract of a Master's thesis should not exceed 250 words. The abstract of a doctoral dissertation should not exceed 350 words. This word limit and the format have been specified so that the abstract will more easily conform to the requirements of thesis or dissertation abstract databases such as Dissertation Abstracts International.

The abstract should not merely repeat the title, nor contain illustrations or tables, use abbreviations, or cite references. It should be an accurate reflection of the original findings reported in the body of the thesis or dissertation.

The abstract with attendant key words should be placed on its own page in the thesis. The title of the thesis or dissertation is repeated above the abstract. Two lines down, the author of the thesis or dissertation is indicated, followed by the degree sought (abbreviated), institution, year, number of pages in the thesis or dissertation, and the thesis or dissertation advisor (major professor). The abstract must be double-spaced beginning two lines beneath the author lines. See Appendix H for the format of the abstract.

Two lines beneath the abstract identify the key words that have been selected to augment those used in your title. A key word is a word that others would search for if they were trying to locate your work using a search strategy. Usually three to five key words are selected. Key words can be alphabetic (drought), numeric (3.14), or alphanumeric (PP333). See the sample given in Appendix H below the abstract. Do not use the same words again that have been used in the title since those words are indexed already as a function of being in the title.

Table of Contents

The heading, TABLE OF CONTENTS, is centered without punctuation two inches from the top of the page: the listing begins at the left margin four line spaces below it. The titles of parts, sections, or chapters and their principal subdivisions are listed and must be worded exactly as they appear in the body of the thesis. If further subdivisions are listed for any section in the table of contents, they must be listed for all sections in the thesis or dissertation. See Appendix I for samples of appropriate formats.

List of Tables

The heading, LIST OF TABLES, is centered without punctuation two inches from the top of this page: the listing begins at the left margin four line spaces below it. Tables must be numbered consecutively throughout the text or alternatively numbered using a system which is a reflection of their location, for example, Tables 3.1, 3.2, 3.3, etc. for tables occurring in Chapter 3. See Appendix J. Appendix tables should be numbered either alphabetically or using the sequence A.1, A.2, A.3, etc. If a table is so long that the caption must be placed on the facing page, the page number that the actual table appears on is the one listed in the List of Tables.

List of Figures

The heading LIST OF FIGURES is centered without punctuation two inches from the top of this page: the listing begins at the left margin four spaces below it. Figures must be numbered consecutively throughout the text or alternatively numbered using a system which is a reflection of their location, for example, Figure 3.1, 3.2, 3.3, etc. for figures occurring in Chapter 3. Appendix figures should be numbered either alphabetically or using the sequence A.1, A.2, A.3, etc. If a figure has a caption on the facing page, the page number that the actual figure appears on is the one listed in the List of Figures. See Appendix K.

List of Plates

This is formatted in the same way as is the List of Figures and is only used if there are Plates within the thesis or dissertation. The listing begins four spaces below the heading.

List of Symbols, Abbreviations and/or Specialized Nomenclature

If necessary to the presentation of the thesis, these lists appear after the Lists of Tables and Figures in the preliminaries using a form or style acceptable to the field of study. The listing begins four spaces below the heading. In Appendix L is a sample List of Abbreviations.

Acknowledgments (Optional)

The heading ACKNOWLEDGMENTS is centered without punctuation two inches from the top of the page: the text begins four line spaces below. Acknowledgements must be short and to point – usually no more than 5 lines. Only persons who provided professional help should be acknowledged (Appendix M).

THE TEXT

Introduction

The introduction is the first chapter of the thesis. The word INTRODUCTION is the title of the first chapter (or major division) and its placement is consistent with that of the other chapter titles.

The Body of the Thesis

Each thesis or dissertation must be divided in some manner of logical organization. The customary major divisions are chapters, but it is permissible to divide a thesis or dissertation into sections. Each chapter (or section) must be numbered consecutively using Arabic numerals.

Each new chapter (or section) must begin on a new page. The chapter number and title (or section number and title) must be in all capital letters. A chapter or section title which requires more than one line is to be double-spaced and centered.

Any logical means of subdivision within the chapter or section is permissible, but the scheme used must be consistent throughout a chapter (or a section). Some chapters may not require subdivisions, while others may require one or more levels for clear organization. The preferred form for first order subdivisions is left justified, bold, and underlined; for second order subdivisions, a centered heading; and for a third order subdivision, an italicized paragraph heading. See Appendix N.

The subdivisions within a chapter (or a section) do not begin on a new page unless the preceding page is filled. If there is not room for the complete heading and at least two lines of type at the bottom of a page, the new subdivision should begin on the next page. It is never correct to carry over the last few words of a paragraph. It is preferable to add an extra line, rather than continue a portion of a line.

Chapter or Section Headings

A center heading for a chapter is centered between the typing margins, with a double line space above and below. The first line of a two-line center heading must be the longer, and the heading is to be double-spaced. Center headings are to be typed with an Arabic numeral and full capitalization of all words in the title. The style selected must be used consistently throughout the thesis or dissertation. See Appendix N.

First Order Subdivision

A left justified heading or first order subdivision is placed with a double line space above and a double line space below the heading. The first letter of each major word of the heading is capitalized and placed in bold type.

Second Order Subdivision

A center heading or second order subdivision is centered and typed in capital and lower case letters. There must be a blank double line space above, and the text begins a double line space below, except when a center heading is immediately followed by a paragraph heading. In this case, a double space separates the two headings.

Third Order Subdivision

No extra spaces are needed to precede a paragraph heading. Only the first word and any proper nouns are capitalized. The entire heading is left justified and italicized. It is followed by a period to differentiate it from the text which follows it. The text begins two spaces after the period.

Alternatively, the third order subdivision may be the opening words of the sentence which begin the paragraph.

Equations

If equations are used in the text, they should be numbered consecutively. The equation is set off from the text by a double line space preceding and following the equation. The identifying equation number is placed in parentheses at the right margin on the same line as the equation (Appendix O).

Footnotes and Endnotes

Footnotes are sometimes used for additional information or for explanatory material. If footnotes are used, they must be numbered consecutively throughout the entire thesis, and must appear at the bottom of the same page on which they are referenced. For assistance, see William G. Campbell, *Form and Style in Thesis Writing*, 4th edition revised, New York: Houghton Mifflin Company, 1976. Writers working in a discipline following the Modern Language Association Handbook may use back notes or endnotes rather than footnotes. See the MLA style manual. Under no conditions are footnotes, endnotes, or back notes to be used for citing literature sources.

Photographs

Several options are available for handling and including photographs in the thesis or dissertation. With the advent of high quality photocopiers, it is now possible to obtain excellent photocopies of the original photograph without loss of detail or contrast. This method is economical even for color copies and provides an image that cannot be detached from the page and later lost.

Another option is to make enough copies of a print photographically to accommodate the number of copies and mount each individually. It is a good practice to label the reverse side of each photograph with the figure number, page number, candidate's last name, and the year. Mount photographs with an adhesive specially prepared for photographic work, good quality rubber cement, or with dry mounting tissue.

A scanner can be used to reproduce photographs. The original image is scanned at a sufficiently high resolution to retain detail and can be incorporated into the thesis or dissertation document and then photocopied.

Preparation of Tables

A table is an array of information presented in columns and consists of numbers and/or words. In the text, a table should appear as closely as possible to the point where it is first discussed, usually no farther than the page following. Table captions should be placed above the table, should be numbered using Arabic numbers, and end with a period (Appendix P).

Tables can be arranged either vertically (Appendix P) or horizontally (Appendix Q) on a page. With a table whose size or format requires horizontal placement, the bottom of the table faces the outside (or unbound) edge of the page. The table, table number, and caption should be oriented so that they can be read when the page is rotated 90° clockwise. Proper margins must still be maintained with particular attention paid to the 1 and 1/2 inch margin of the binding edge. The page number should appear in the usual position at the bottom of the page. If more than one-half page in length, an individual table should be put on a separate page. More than one table can be put on an individual page if captions can be placed in their proper positions and if adequate space (at least 1/2 inch) is provided between tables.

A table can be incorporated directly in the text if it is small (less than one half of a page in length), it can be confined to one page, and it occurs in numerical order after its first mention in the text (Appendix R). The table must be offset by a double space preceding and following it.

If a table is very long and must be typed on more than one page, show the table number on the additional page(s) with a notation of continuation (Appendix S). Show all column headings as necessary on the additional page and footnote on each page where the information applies.

If a table does not fit on a single page within the specified margins, it can be typed on a larger sheet which is the equivalent of two pages (11x15 inches). This larger sheet can

then be folded so that the folded edge is recessed inside one quarter of an inch from the outside (unbound) edge of the thesis or dissertation. Larger sheets can be folded twice, as shown in Appendix T, or placed within a pocket as described later in the section, *Non-Duplicative Materials*.

Preparation of Figures

Some general guidelines for the production of figures are listed below:

- Use line graphs for continuous data and bar graphs for discontinuous data.
- Use consistent symbols throughout.
- Designate the curves with individual labels or use an inserted legend to differentiate between treatments.
- Avoid wasted space.

In the text, a figure should appear as closely as possible to the point where it is first discussed, usually no farther than the page following. Figure captions should be placed outside and at the bottom of the figure two line spaces below it (Appendix U) and followed by a period.

If placed horizontally on the page, the bottom of the figure should be at the right side of the page, with allowances for the proper margins (Appendix V). The caption must be oriented to be read with the figure. The page number should appear in the usual position at the bottom of the page.

Figures less than one-half page in length (including caption) may be placed within the text (Appendix W). The figure should be set off with two lines preceding and following its placement in the text. If more than one-half page in length, an individual figure should be put on a separate page. More than one figure can be put on an individual page if captions can be placed in their proper positions and if adequate space is provided between the figures (at least 1/2 inch apart). Figures with component parts (A, B, C) may be titled as one figure, with the alphabetical designation placed below and to the right of the individual part and the caption placed below the entire group.

Appendices (Optional)

This section is usually added to contain supplementary illustrative material, original data, and detailed explanations too lengthy for inclusion in the text or not immediately essential to the understanding of the section. See Appendix X for a sample appendix. The APPENDICES may be divided into Appendix A, Appendix B, etc., depending on the kinds and the amounts of material used. Each appendix with its title must be listed separately in the Table of Contents as a subdivision under the heading APPENDICES.

References

Any thesis or dissertation which makes use of other works, either in direct quotation or by reference, must contain a Reference page. The heading REFERENCES is centered, without punctuation, two inches from the top of the page. The first entry begins four line spaces below it. The References are double-spaced between entries, single-spaced within each entry. Reference entries should conform to the style prominent in the student's particular field of study. It is mandatory to get all sources cited in the text as well as all sources used to garner key concepts in the References.

Entries in the References should be placed in alphabetical order. See Appendix Y. When ordering multiple entries by the same authors, make certain that the same ordering principle is used consistently throughout the Reference page.

Fly Page

The fly page at the end of the thesis or dissertation is the same as the one at the beginning. The fly page is a blank sheet of paper that contains no information of any type. It is neither counted nor numbered.

The Thesis or Dissertation Defense

4

Awareness of the Professional Setting

Purpose of the Thesis or Dissertation Defense

The thesis or dissertation defense is the culminating event in the pursuit of a Master's or a Ph.D. degree. The plan of study is complete, the research has been finished, the thesis or the dissertation is written and the final draft is submitted to the Dean of Graduate Studies and to the members of the thesis or dissertation committee. Once preliminary approval of the draft has been given by the Chairman of the Graduate Committee and each of the members, the thesis or dissertation defense can be scheduled with the approval of the Dean of Graduate Studies. Ample time must be given to the committee so that they can examine the draft thesis or dissertation thoroughly. After these preliminaries are done, the final event to occur is conducting the thesis or dissertation defense. The primary purpose of this event is not to evoke anxiety or stress in the candidate but to allow the degree candidate to demonstrate the level of his or her knowledge thus insuring that it is appropriate to the degree being conferred.

A student may not expect to defend the thesis or dissertation in the same semester that their proposal is submitted and approved. The proposal is intended to be a plan or guide for the research to be conducted, submitted in advance of conduct of the actual research work and not after the research has been done.

What are the parts of a thesis or dissertation defense?

Once the defense has been scheduled, notices are distributed throughout the department and school advertising the event, giving the name of the candidate, the thesis or dissertation title, the time, date, and location for the event. Phase I of the thesis or dissertation defense, the presentation of research made by the candidate, is open to the public. For Phase II of the thesis or dissertation – the actual questioning of the candidate, the public is excused and the questioning is conducted only in the presence of the graduate committee and the Dean of Graduate Studies.

What is a typical scenario for the defense?

How is the actual thesis or dissertation defense handled?

The typical defense starts with the student (dressed in an appropriately professional manner) facing his or her committee with the audience made up of members of the department school, or the public arrayed behind the members of the graduate committee. The Chair of the Graduate Committee (major professor) will call the defense to order and thank the members of the committee, and the members of the audience for participating in this important event in the life of the candidate. At that time, the major professor will ask the candidate to say a few words about themselves. This has two functions – First, it allows the candidate to acquaint the audience and committee members with details of his or her professional life and; secondly it allows the candidate to begin using his or her voice so that it will function when the presentation begins.

What happens in phase I of the thesis or dissertation defense?

Typically, the candidates present a brief history of themselves by relating the events bringing them to the present point in time and the research topic....then they can easily transit into the title and topic of their thesis or dissertation using a PowerPoint presentation, overheads, or a Lightshow format. The presentation should consist of an introduction to the research, the objectives, the methodology, the primary results, and the significance of the work. This presentation typically takes from 30 to 45 minutes. Before the presentation starts, the major advisor usually requests the members of the committee to hold their questions until the second phase of the defense and the public to hold their questions until immediately after the presentation. The only questions which should be asked during the actual presentation are those which contribute to immediate clarity or further understanding. At the conclusion of the presentation, the major advisor will then invite general questions from the audience (but not the committee). If there are an excessive number of questions or the discussion resulting from those questions takes up too much time, it is the prerogative of the major professor to terminate the audience's question time. If there are no further questions, the major professor excuses the audience and the audience leaves the room.

Who brings the cookies?

It has become traditional in some departments for the committee and the candidate to take a brief break at that time and partake of snacks and drinks provided for the occasion by the candidate or friends and family of the candidate. After this short break, the candidate, major professor, members of the committee and the Dean of Graduate Studies reassemble in the room where the thesis or dissertation examination process will take place.

What happens in Phase II?

When the committee has reassembled, the formal examination process begins. Usually, the major professor begins with a general question to help get the process started and allow the candidate to focus on the task at hand. After this exchange, each member of the committee is given an opportunity to ask questions. If one member of the committee has asked a question and a second member has a related question, then the second member may ask it. No one member may monopolize the entire question session.

What is the role of the major professor?

The role of the major advisor is an important one. The major advisor helps to orchestrate the questioning process and may have to act to move the process on to various members of the committee to give each one a chance to ask questions. The major advisor, however, may not...

- Answer the questions for the candidate.
- Couch questions in such a way that the answer is given or obvious.
- Rephrase questions of other members to give away the answer to the question.

In all cases, the major professor must allow the candidate to speak. If the candidate is confused about a question, the candidate may request that the question be rephrased or asked in other words. The questioner may then respond.

It is the candidate's responsibility to answer as completely as possible and to try to answer all the questions. If the candidate does not know the answer, they should try to remain calm for the remaining questions. There is an old axiom that maintains "the committee will continue to ask questions in a defense until they finally get one that the candidate does not know!" However, it is far better if the question you cannot answer is *not* the first one!

What constitutes unprofessional behavior?

Professional behavior should be maintained throughout the entire examination process. Both the candidate and the committee members deserve and should receive respect. At no time should the major professor or any member of the committee disparage, impugn the intelligence of, or make demeaning comments about the candidate or the candidate's performance. Questions should be asked in as fair a manner as possible and not with the intent of torpedoing the candidate. There are also anecdotal stories of committee members who have engaged in heated arguments over aspects of the research or its interpretation. In some cases, they dominate the defense to the point that the candidate has very little to do besides stand in the room. This type of grandstanding is unprofessional and detracts from the primary purpose of the thesis or dissertation defense – that is to test the candidate's knowledge. It is not appropriate and should not take place in that setting.

And what happens after the questions are over?

After the questioning has been completed and no member of the committee has any further questions, the candidate is asked to leave the room (but not the vicinity). There have been occasions when the candidate has left the immediate area and then could not easily be found at the conclusion of the deliberations. At this time, the committee discusses the candidate's performance and a consensus is taken. The signature page of the thesis or dissertation examination (Appendix C) is completed and signed by the members of the committee. This page must be returned to the Dean of Graduate Studies. It is important for the committee to remember that the candidate is waiting anxiously outside

for the verdict of the committee. When a conclusion has been reached, the candidate is invited back into the room and given the decision.

If the performance was not adequate, the candidate will have to try again and may have to meet additional requirements stipulated by the graduate committee. If the performance was satisfactory, the candidate is usually greeted by hearty congratulations upon re-entering the room.

The thesis or dissertation defense is an important event and marks the first time that the candidate truly expounds on and defends the meaning and significance of his or her research and knowledge of the discipline before a group of soon-to-be peers and colleagues. It is hoped that this is merely the first real stepping stone on a path leading to many future professional successes.

Electronic Thesis & Dissertation Procedures

5

*Opens access
of thesis and
dissertation
work to a
world-wide
audience*

Electronic Thesis and Dissertation Process (ETD) at Alabama A&M University

Starting on August 1, 2012 all thesis and dissertation papers must be submitted, approved and accessed electronically. Electronic formatting provides several benefits including: improved access to research, reduced expense to authors, better presentation of research, and environmental sustainability.

Benefits of Preparing an ETD

Creating a thesis or dissertation in electronic format and publishing it online has a number of important benefits when compared to writing a traditional format paper.

1. Enhanced Presentation

Allows students to produce visually appealing thesis and dissertations that presents The original ideas and creative work of a student.

2. Greater Visibility

Opens access of thesis and dissertations to a world-wide audience.

3. Improved Control

Allows students to control the availability of their thesis or dissertation by choosing:

- To embargo it (i.e. to make it unavailable to anyone for a specified period of time).
- or to make it available to interested readers worldwide.

4. Lower Printing and Copying Costs

Allows students to save on printing and copying costs through electronic publishing and information exchange.

5. Enhanced Student Creativity in the Design of Thesis and Dissertation Papers

Provides students with the ability to use advanced software programs to produce animations, sounds, and interactive multimedia simulation in thesis and dissertations.

Submission Steps:

1. Students deliver a hard copy or an electronic draft of your thesis or dissertation to their major advisor and thesis or dissertation committee members.
2. After review and approval by the advisor and thesis/dissertation committee the student must submit an electronic draft to the Graduate School, using their bulldog email account, as MS Word to thesisdissertation@aamu.edu. Students must also submit, to the Graduate School, as a hard copy, a signed copy of the *Thesis/Dissertation Format Sanction Form* (this form confirms that the advisor and the thesis/dissertation committee have reviewed the paper and ensure that the paper meets the specifications outlined in the Thesis/Dissertation Guide) signed by their thesis/dissertation advisor to the Graduate School.
3. Upon receipt of the electronic thesis/dissertation and the supporting Thesis/Dissertation Format Sanction Form the Graduate School will submit the papers to the Writing Review Center for review of grammar and punctuation (Please note this review is not a comprehensive review and only indicates notable problems that might be found in the paper. As mentioned previously, it is recommended that all students submitting thesis or dissertation papers seek professional assistance with editing, and format review. Students who submit papers that exhibit notable problems a second time, during a given semester, must wait until the next academic semester before resubmitting.
4. After review by the Writing Center, the Graduate School will send a copy of the paper to the thesis or dissertation advisor for distribution to the student (It is advised that at this point advisors should meet with students, if needed, to develop plans of action and a

*The Graduate
School only
accepts
electronic
searchable
PDF or MS
Word versions
of thesis and
dissertation
papers*

time-line for correcting grammatical and stylistic issues) .

5. After review by advisor (and the completion of all necessary corrections) students must submit copies in searchable MS Word format to thesisdissertation@aamu.edu (students with papers which have notable grammatical and style problems as indicated above must repeat steps 1-3).
6. At this point, thesis and dissertation papers are checked to ensure that they comply with the relevant format specifications outlined in the *Thesis and Dissertation* guide and conform to the style in which the paper is written. Student papers which exhibit problems at this stage are sent back to the thesis and dissertation advisor for distribution to the student (It is advised that at this point advisors should meet with students to develop plans of action and a time-line for correcting formatting issues. Upon making the necessary corrections students must repeat steps 5-6. However under no circumstance will a paper be reviewed more than twice in a semester).
7. Assuming the oral defense is successful, the student should make any changes or corrections requested by the committee and convert final copy into a searchable PDF format. The student should then go to www.etsadmin.com/aamu, click the “submit my dissertation/thesis” link and as instructed, create an account. After the student has activated the account, the student can log in and follow the instructions to upload the PDF Thesis/Dissertation. (Graduate School will automatically be notified of the Thesis/Dissertation submission.). One hardcopy title page, on plain paper, is required and should contain the signatures of all members of the thesis or dissertation committee. The title page of the electronic thesis does not need to be signed but should have the names of the committee typed in the appropriate underlined spaces and a blank underlined space should be left for the Dean’s electronic signature. Additionally, students must submit one hardcopy copy of the thesis or dissertation for binding. This copy of the paper must be printed on 25% cotton bond paper and the title page must contain the signatures of all members of the thesis of dissertation committee.
8. At the conclusion of this process the electronic of the

thesis or dissertation is forwarded to the Reference Librarian in Drake Learning Resources Center where it is catalogued and archived.

Final Electronic Copy: A note before submitting your final copy

The ease of access to ETD's may create issues with prior publication for journals or publishing houses, and for the prosecution of patents. Check with your advisor before you submit your thesis or dissertation so you can choose the most appropriate release option for your work. There are access restrictions that may be placed on a thesis or dissertation when it is submitted to the Graduate School.

To address these publication issues check the Electronic Thesis and Dissertation (ETD) Submission Form or with the Graduate School for more information, before submitting your final copy.

The following are options on the Electronic Thesis and Dissertation Submission Form:

- Release the entire work immediately for access worldwide.
- Release the entire work for Alabama A&M University access only.
- Release the entire work for Alabama A&M University access only, while at the same time releasing only the following parts of the work (e.g., because other parts relate to publications) for worldwide access (separate files must be submitted to use this option) for: one year, three years, or indefinitely.
- Delay the release for a period of no more than one year for purposes of patent protection. After the selected time has passed the ETD will be released worldwide.

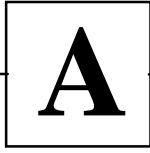

Suggested References to Aid the Student in Writing

Spelling

Even if slightly uncertain about the correct spelling of a word, the student should use a good contemporary dictionary to verify the spelling. Spelling checkers that are often part of word processing systems cannot differentiate between words that are correctly spelled but wrongly used (*there* vs. *their*, *its* vs. *it's*) and thus do not take the place of careful proofreading. The spelling used must conform to American usage standards.

Elements of Style such as Grammar, Punctuation, and Usage

American diction, particularly the use of articles (a, the), is required in the thesis or dissertation. All thesis and dissertation papers must conform to either MLA, APA, or Chicago styles which set guidelines for references, tables, figures, margins, page numbering, quotations, etc. (students should meet with their thesis or dissertation advisor to determine the appropriate style). The titles listed below are suggested as an aid to avoid errors format, usage, and punctuation.

Where can a student find help?

Publication Manual of the American Psychological Association, (6th ed.) published by the American Psychological Association, Washington, D.C., 2010.

MLA Handbook for Writers of Research Papers, (7th ed.) published by the Modern Language Association, New York, 2009.

The Chicago Manual of Style (16th ed.), published by the University of Chicago Press, Chicago, 2010.

B

Sample Milestone Chart for the Thesis or Dissertation Proposal

Milestone charts or task timetables are very useful tools for helping you to plan your research. Not only do they provide an immediate visual reference as to the tasks and the time required to complete each, but they also serve as a reminder to help keep the graduate student on track toward completion of the thesis or dissertation research. They can simplify the description of a complicated series of events and can be used to indicate when the completion of one event is necessary before the start of another. Many computer applications are capable of creating milestone charts. The simple one shown here was made using a Macintosh program, MacDraw II, but spreadsheet programs can also be used.

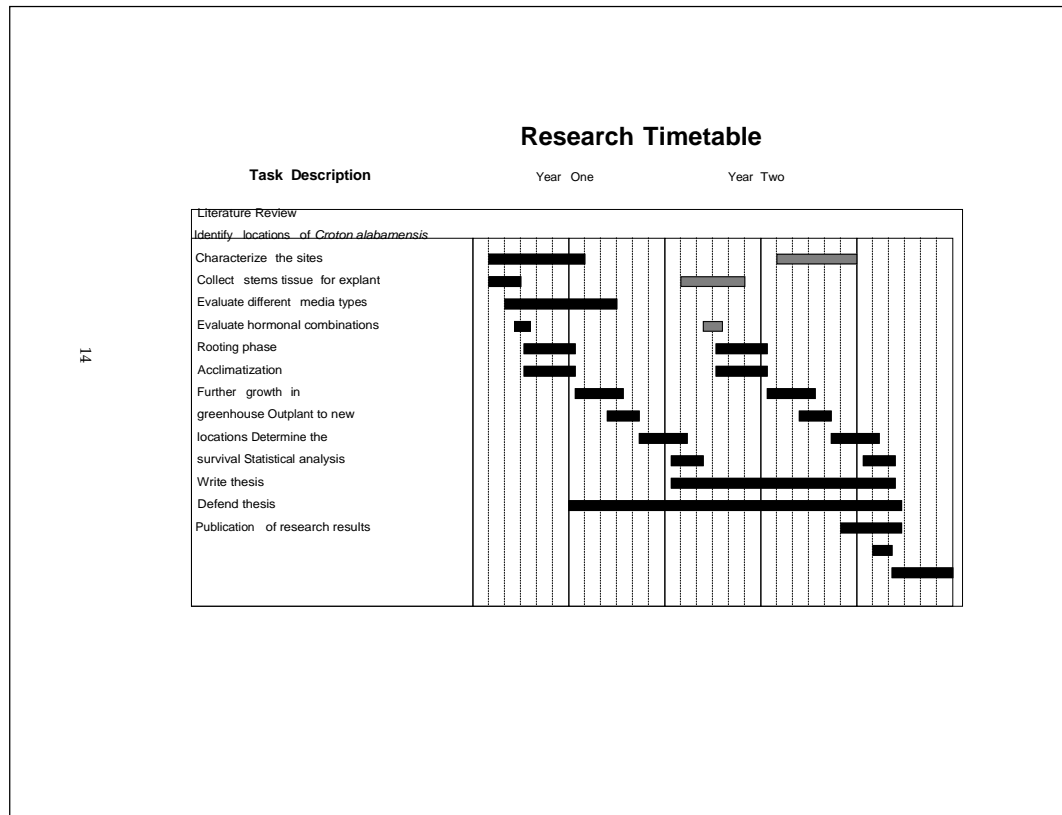

14

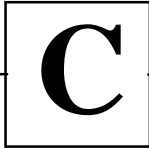

Signature Page for the Oral Examination of Thesis or Dissertation

ALABAMA AGRICULTURAL AND MECHANICAL UNIVERSITY
NORMAL, ALABAMA 35762
SCHOOL OF GRADUATE STUDIES
COMBINED FACULTY JUDGMENT
Oral Examination on THESIS or DISSERTATION (Circle one)

Name of Candidate _____ Date _____
Area of Specialization _____
Thesis Committee Members _____
Title of Thesis _____

Has the candidate _____ (Circle One)

(1) effectively presented the objectives, techniques and findings of his or her thesis/dissertation?	Yes	No
(2) shown adequate depth of knowledge of the results and implications of his or her thesis/dissertation?	Yes	No
(3) shown adequate depth of knowledge of his or her field of study in relationship to the degree being conferred?	Yes	No
(4) shown adequate awareness of the professional setting of his or her thesis or dissertation defense	Yes	No

The examining committee recommends that the oral examination on the thesis or dissertation be approved or rejected (circle one). _____

Chairman of the Oral Examination of Thesis/Dissertation _____

This judgment was approved by committee members _____

The signature page represented here is printed at 60% scale as an example only. The signature page for the oral examination of the thesis or dissertation is brought to the defense by the Dean of Graduate Studies.

D

Sample Title Page for the Thesis or Dissertation

This page (shown at 60% of normal size) illustrates the format to be used for the thesis or dissertation title page.

GROWTH EVALUATION OF FOUR AQUATIC PLANT SPECIES ON
FLOODED STRIP MINE SPOIL MATERIALS

by
CONSTANCE ROCHELLE BUFORD

A THESIS

Submitted in partial fulfillment of the requirements
for the degree of Master of Science
in the Department of Plant and Soil Science
in the School of Graduate Studies

Alabama A&M University
Normal, Alabama 35762

April 1995

Source: Constance Rochelle Buford Growth Evaluation of Four Aquatic Plant Species on Flooded Strip Mine Spoil Materials." Master of Science Thesis, Department of Plant and Soil Science, Alabama A&M University, Normal, AL, April 1995.

Sample Certificate of Approval for the Thesis or Dissertation

E

This page (shown at 60% of normal size) illustrates the format to be used for the certificate of approval page in the thesis or dissertation.

Submitted by CONSTANCE BUFORD in partial fulfillment of the requirements for the degree of MASTER OF SCIENCE specializing in PLANT AND SOIL SCIENCE.

Accepted on behalf of the Faculty of the Graduate School by the Thesis Committee:

Major Advisor

_____ Dean of the Graduate School

_____ Date

ii

Source: Constance Rochelle Buford "Growth Evaluation of Four Aquatic Plant Species on Flooded Strip Mine Spoil Materials." Master of Science Thesis, Department of Plant and Soil Science, Alabama A&M University, Normal, AL, April 1995.

Sample Copyright Page for the Thesis or Dissertation

F

This page (shown at 60% of normal size) illustrates the format to be used for the thesis or dissertation copyright page. Note that the full legal name is used and capitalized.

Copyright by
CONSTANCE ROCHELLE BUFORD
1995

iii

Source: Constance Rochelle Buford "Growth Evaluation of Four Aquatic Plant Species on Flooded Strip Mine Spoil Materials." Master of Science Thesis, Department of Plant and Soil Science, Alabama A&M University, Normal, AL, April 1995.

Sample Dedication for the Thesis or Dissertation

G

This page (shown at 60% of normal size) illustrates the format to be used for the dedication page in the thesis or dissertation.

This thesis is dedicated to my beloved wife Rosa María and my gracious son Leonardo José for their long wait and unceasing support, and also my classmates in Escuela Nacional de Agricultura "Class of 84" who never had the opportunity to pursue a higher degree.

iv

Source: Leonardo R. Alvarez, "Growth and Exudate Analysis of 'Loring' and 'Redhaven' Peaches Under Variable Root Restriction." Master of Science Thesis, Department of Plant and Soil Science, Alabama A&M University, Normal, AL, November, 1993.

H

Sample Abstract and Key Words for the Thesis or Dissertation

This page (shown at 60% of normal size) illustrates the format to be used for the page containing the abstract and the key words. Notice that the key words are identified and do not duplicate words already used in the title.

MARKETING RIDESHARE/CARPOOLS AS A COMMUTER TRANSPORTATION
OPTION FOR MEDIUM-SIZED CITIES: HUNTSVILLE, ALABAMA, AS A CASE
STUDY

Heidish, Louise, M.S., Alabama A&M University, 1994. 140 pp.

Thesis Advisor: Constance Jordan

The daily work commute trip is the most regular for American citizens. In order to conserve natural and personal economic resources, the commuters could consider carpooling for this purpose. Carpooling is done in large urban areas. It requires behavioral change for the motorist who traditionally loves his mobility independence. A thirty month city-sponsored public relations campaign to market carpooling was conducted in Huntsville, Alabama, from 1988 through 1990. This campaign was studied to determine what strategies could be recommended to medium-sized cities for their use. The major employers were profiled for a variety of factors which might contribute to their employees' willingness or disinterest in obtaining carpool information. The involvement of the Chamber of Commerce leadership was also assessed because the Chamber had endorsed the carpool program, RideShare, through its appropriate committee channels. Individual inquiries were made to workers who responded to the highway sign strategy. These direct mail surveys produced a disappointing number of responses. Finally, a comparison of carpool programs in selected cities discussed in Huntsville's Vision 2000 study was made. The evidence derived from the descriptive research study indicates that changing commuter behavior is difficult. It will require lengthy and persistent marketing campaigns and possibly changes in the price of gasoline.

KEY WORDS: company profiles, surveys, Vision 2000 cities

v

Source: Louise Oridge Schwallie Heidish, "Marketing Rideshare/Carpools as a Commuter Transportation Option for Medium-Sized Cities: Huntsville, Alabama, as a Case Study." Master of Science Thesis, Department of Community Planning and Urban Studies, Alabama A&M University, Normal, AL, May 1994.

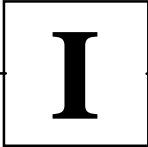

Two Sample Formats for the Table of Contents

These pages (shown at 50% of normal size) illustrates two different formats which can be used for the table of contents page in the thesis or dissertation. In the example to the left, the introduction is used as the first chapter. In the example below, the introduction precedes the first chapter. Either format is equally acceptable.

TABLE OF CONTENTS

CERTIFICATE OF APPROVAL ii

ABSTRACT AND KEYWORDS v

LIST OF TABLES vii

LIST OF FIGURES ix

CHAPTER 1 - INTRODUCTION 1

Problem Statement 1

Objective of the Investigation 2

CHAPTER 2 - LITERATURE REVIEW 3

An Overview of CASE Technology 11

Usage of CASE Tools in Software Development 11

CHAPTER 3 - COST/FUNCTIONALITY ANALYSIS

CHAPTER 4 - RESULTS AND DISCUSSION

CHAPTER 5 - CONCLUSION

APPENDICES

Upper Case Tool Characteristics

Upper Case Tool Information Sheets

BIBLIOGRAPHY

VITA

vi

TABLE OF CONTENTS

CERTIFICATE OF APPROVAL ii

ABSTRACT AND KEYWORDS v

LIST OF TABLES vii

LIST OF FIGURES ix

INTRODUCTION 1

Problem Statement 1

Objective of the Investigation 2

CHAPTER

1 - LITERATURE REVIEW 3

An Overview of CASE Technology 5

Usage of CASE Tools in Software Development 11

2 - COST/FUNCTIONALITY ANALYSIS 21

3 - RESULTS AND DISCUSSION 31

4 - CONCLUSION 36

APPENDICES 38

Upper Case Tool Characteristics 38

Upper Case Tool Information Sheets 50

BIBLIOGRAPHY 50

VITA

vi

Source: Carrondeveon Battle, "A Cost/Functionality Analysis of Computer-Aided Software Engineering Tools." Master of Science Thesis, Department of Computer Science, Alabama A&M University, Normal, AL, May, 1994.

J

Sample List of Tables for the Thesis or Dissertation

This page (shown at 60% of normal size) illustrates the format to be used for the page containing the List of Tables. Tables can be numbered consecutively with Arabic numbers or to reflect their location in chapters, 3.1, 3.2, 3.3, etc.

LIST OF TABLES

Table	Page
1. The percentage of electrolyte leakage (%) from stem sections of six <i>Actinidia</i> species evaluated by conductivity tests in the growth chamber in response to four temperatures	37
2. The percentage of electrolyte leakage (%) from stem sections of six <i>Actinidia</i> species evaluated by conductivity tests in the field in response to four temperatures	45
3. The killing temperatures (LT ₅₀) of <i>Actinidia</i> species evaluated by triphenyl tetrazolium chloride tests in both the growth chamber and the field	47
4. The rank correlations between different methods of evaluating cold damage and trial locations using Spearman Correlation Coefficient to determine statistical significance	50
5. Difference between endogenous ABA levels (pmol/g) in stem sections of <i>Actinidia</i> species measured at the onset of dormancy and during deep dormancy in the growth chamber in response to paclobutrazol	62
6. Difference between endogenous ABA levels (pmol/g) in stem sections of <i>Actinidia</i> measured at the onset of dormancy and during deep dormancy in the field	63

viii

Source: Wui Zang' "Relationship between Cold Hardiness in *Actinidia*, Endogenous ABA Levels, and the Effect of Paclobutrazol." Master of Science Thesis, Department of Plant and Soil Science, Alabama A&M University, Normal, AL, November 1989.

K

Sample List of Figures for the Thesis or Dissertation

This page (shown at 60% of normal size) illustrates the format to be used for the page containing the List of Figures. Figures can be numbered consecutively with Arabic numbers or to reflect their location in chapters, 3.1, 3.2, 3.3, etc.

LIST OF FIGURES

Figure	Page
1. Adventitious shoot development at the leaf petiole base	34
2. Adventitious shoot buds and protocorm-like bodies	37
3. Plantlets initiated from leaf petioles	38
4. Influence of TDZ and IBA on shoot quality	43
5. Response of shoot tip and petiole to TDZ for callus formation, pooled over dicamba concentration	53
6. Response of shoot tip and petiole to dicamba for callus formation.....	54
7. Influence of dicamba and TDZ on callus formation.....	55
8. Yellow friable shoot tip callus from dicamba medium	56
9. Compact organogenic callus induced in medium containing dicamba and TDZ	59
10. Brown protocorm-like bodies	65

Source: Leopold Nyochembeng, "Intro to Adventitious Regeneration in Cocoyam." Master of Science Thesis, Department of Plant and Soil Science, Alabama A&M University, Normal, AL, December 1994.

L

Sample List of Abbreviations for the Thesis or Dissertation

This page (shown at 60% of normal size) illustrates the format to be used for the thesis or dissertation List of Abbreviations page.

LIST OF ABBREVIATIONS

CELSS - Controlled Ecological Life Support System
EBI - Edible Biomass Index
EBIL - Edible Biomass Index for Lettuce
EBIR - Edible Biomass Index for Radish
EC - Electrical Conductivity
ELS - Edible Lettuce Shoot
HI - Harvest Index
HPS - High Pressure Sodium Lamp
KW - Kilowatt
LAI - Leaf Area Index
NASA - National Aeronautics and Space Administration
NFT - Nutrient Film Technique
PAR - Photosynthetic Active Radiance
PPFD - Photosynthetic Photon Flux Density
RESO - Radish Edible Storage Organ
SM - Salad Machine
S/R - Shoot to Root Ratio
S/RESO - Radish Shoot to Edible Storage Organ Ratio
SSF - Space Station Freedom

Source: Raymond Boskiel, "Comparison of Radish and Lettuce Grown in Nutrient Solution from Separate and Shared Reservoirs using the Nutrient Film Technique Hydroponic System." Master of Science Thesis, Department of Plant and Soil Science, Alabama A&M University, Normal, AL, April 1993.

Sample Acknowledgments for the Thesis or Dissertation

M

This page (shown at 60% of normal size) illustrates the format to be used for the acknowledgments page in the thesis or dissertation.

ACKNOWLEDGMENTS

I would like to express my sincere appreciation to the advisory committee members Dr. Chih-Cheng Hung, Dr. Ramesh Adusumilli, Dr. Gerald Wheelock and a special thanks to Mr. Surendar R. Pulusani for serving as the chairperson. I would also like to express my sincere appreciation to the many individuals and groups on the Internet who have provided me with an endless support of information pertaining to my thesis work.

xii

Source: Ravi Chitturi, "An Object-Oriented Approach to Database Management Systems." Master of Science Thesis, Department of Computer and Information Sciences, Alabama A&M University, Normal, AL, July 1994.



Sample Beginning Page of a Chapter for the Thesis or Dissertation

This page (shown at 60% of normal size) illustrates one possible format that can be used for the first page of a chapter and shows how major divisions and first, second and third order subdivisions occurring in the text are handled.

The chapter heading and title start 2 inches below the top of the page. Text begins four heading.

First and Second Order Subdivisions start four lines spaces below the end of the preceding paragraph.

CHAPTER 2

MATERIALS AND METHODS

Each major subdivision of the thesis or dissertation begins on a new page with the heading two inches from the top of the page and centered over the text. The major subdivision should be capitalized without punctuation as shown above. Begin the text four line spaces below the heading.

FirstOrderSubdivision

The title of the first order subdivision can be left justified and placed four line spaces below the previous sections. The title is placed in upper and lower case and may be distinguished from the rest of the text by placing it in bold and/or by underlining it.

Second Order Subdivision

The second order subdivision title is placed four line spaces below the previous section and is centered over the text. It should be distinguishable from the style of the first order subdivision. The paragraph begins two lines down from the title.

Third order subdivision. This title is placed in italics, is followed by a period, and the text begins immediately after it.

Third order subdivisions may also be the opening words of the sentence which begins the paragraph such as in this example. Either format is equally acceptable.

#

This page (shown at 60% of normal size) illustrates an alternate format that can be used for the first page of a chapter and shows another way to handle major divisions and first, second and third order subdivisions occurring in the text.

Text is double-spaced throughout the thesis or dissertation

Numbers on all pages including the first page of every major division of the thesis or dissertation are placed one inch above the bottom edge of the sheet and centered.

CHAPTER 2

MATERIALS AND METHODS

Each major subdivision of the thesis or dissertation begins on a new page with the heading two inches from the top of the page and centered over the text. The major subdivision should be capitalized without punctuation as shown above. Begin the text four line spaces below the heading.

2.1 First Order Subdivision

The title of the first order subdivision can be set off using a number and title format that is left justified and placed four line spaces below the previous sections. The title is placed in upper and lower case and may be distinguished from the rest of the text by placing it in bold or by underlining it.

Second Order Subdivision

The second order subdivision title is placed four line spaces below the previous section and is centered over the text. The paragraph begins two lines down from the title.

Third order subdivision. This title is placed in italics, is followed by a period, and the text begins immediately after it.

Third order subdivisions may also be the opening words of the sentence which begins the paragraph such as in this example. Either format is equally acceptable.

#

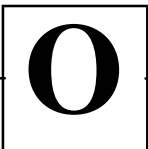

Sample Page Containing Equations for the Thesis or Dissertation

This page (shown at 60% of normal size) illustrates the format to be used for a page containing equations. Note how equations are numbered consecutively on the right side of the page.

$$\theta = 0.61\lambda/n_o d \tag{8}$$

λ is the wavelength of the light in vacuum. Self-trapping is expected to occur if total internal reflection occurs for all rays that are contained within the beam, that is if $\theta_d = \theta_o$.

If equations (7) and (8) are compared, self trapping will occur if

$$\delta n = 1/2 n_o (0.61\lambda / \delta n_o)^2 \tag{9a}$$

or if
$$d = 0.61 \lambda (2n_o \delta n)^{-1/2} \tag{9b}$$

Taking equation (4) and replacing dn by n_2I , it is seen that the diameter of a self-trapped filament is related to the intensity of the light within the filament by

$$d = 0.61 \lambda (2n_o n_2 I)^{-1/2} \tag{10}$$

The power contained in a filament for which the diameter is given in equation (10) is given by

$$P_{cr} = \pi /4 d^2 I \tag{11}$$

$$= \pi(0.61)^2 \lambda^2 /8 n_o n_2 \tag{12}$$

Source: Angela Shields, "Gowhard Nonlinear Optical Characterization of Benzil." Master of Science Thesis, Department of Physics, Alabama A&M University, Normal, AL, November 1993.

P

Sample Table Showing Vertical Placement

This page (shown at 60% of normal size) illustrates the format to be used for placing in the thesis or dissertation a table whose primary orientation is vertical.

Table 5. Frequency of shoot organogenesis in petiole explants.

IBA (μM)	TDZ (μM)	% Shoot Buds	% Plantlets	Color
0	0	50.0 de*	37.5	green
	2.27	77.7 bc	0	light green
	9.08	50.0 de	0	green
2.07	0	100.0 a	55.5	green
	2.27	44.4 e	0	light green
	9.08	77.7 bc	0	light green
4.14	0	75.0 bc	50	green
	2.27	55.5 cde	0	green
	9.08	75.0 bc	0	light green
8.28	0	62.5 bcde	50.0	green
	2.27	55.5 cde	0	light green
	9.08	88.8 ab	0	light green
16.5	0	37.5 e	25.0	green
	2.27	71.4 bcd	0	light green
	9.08	60.0 cde	0	light green

*Numbers with the same letter are not significantly different at $p=0.05$ (STP, Chi square test)

40

Source: Leopold Nyochembeng, "Intro to Adventitious Regeneration in Cocoyam." Master of Science Thesis, Department of Plant and Soil Science, Alabama A&M University, Normal, AL, December 1994.

Sample Table Showing Horizontal Placement

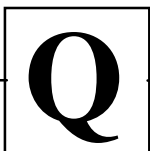

This page (shown at 60% of normal size) illustrates the format to be used for placing in the thesis or dissertation a table whose primary orientation is horizontal.

The margins should still remain consistent with the rest of the thesis or dissertation.

The table's number and caption should be placed at the top of the table so that they can be read with the page rotated 90° clockwise.

Note the position of the page number at the bottom of the page.

Table 6. Effects of different supplementation levels of partially defatted peanut flour on texture indicators and total volume* of wheat dough baked in a microwave oven for 50 seconds.

Peanut Flour (%)	Modulus of Elasticity (kPa)	Weight Loss (%)	Density (kg/m ³)	Total Volume (cm ³)
0	489.06	18.42 a	404.06 c	41.43 a
10	458.34	17.85 a	464.06 b	35.47 b
20	493.77	16.28	558.68 a	31.29 c

* Means in each column followed by the same letter are not significantly different (n=12), (p>0.05)

Source: Bin Pan, "The Effect of Peanut Flour Supplementation on Textural and Rheological Changes of Wheat Dough During Microwave Baking." Master of Science Thesis, Department of Food Science and Animal Industries, Alabama A&M University, Normal, AL, July 1994.

R

Sample Page Showing Table Integrated into the Text

This page (shown at 60% of normal size) illustrates the format to be used for integrating tables into the text. This method is used only for small tables which constitute less than one half of the page in length.

twice as high as that in leaves of seedlings grown in the growth chamber.

Since stomata basically are confined to the abaxial surface, we only used the abaxial surface in density counts. Stomatal densities were significantly higher in the IBA control than in the PAC-treated leaves (Table 5-3). The stomatal density of UNI-treated leaves was lower than the control but not significantly (Table 5-4).

Table 5-4. Stomatal density and conductance means*. Source

	Stomatal Density	Stomatal Conductance
	No./ square cm	cm/sec
IBA	656.7 a	0.66 a
Uniconazole	603.34 a	0.64 a
Paclobutrazol	526.67 b	0.57 a

* Each mean represents 6 replications.

The stomatal density of Line #4 leaves also was significantly lower than Line #2. Perhaps PAC affects water loss during the stressful acclimatization phase in part by decreasing the density and conductance of stomata normally altered by the in vitro environment. UNI is less mobile than PAC through xylem translocation (Sterrett, 1987) and therefore a slightly higher concentration of UNI applied in vitro could possibly significantly affect stomatal density favorably without overly retarding in vitro growth.

Stomata (guard cells and aperture) on leaves of the IBA control were slightly more circular in shape than either the triazole-treated or the greenhouse seedling stomata. In control plants sampled immediately after removal from culture, 90-95% of the stomata were open as determined by SEM. This contrasts with both the triazole-treated and the greenhouse-grown plants at 50-55% (Figure 5-9 and 5-10).

99

Source: Marybeth Knust Eliasson, "Intro to Acclimatization of Genotypes of *Prunus serotina* using Triazole Growth Retardant Pretreatments." Master of Science Thesis, Department of Plant and Soil Science, Alabama A&M University, Normal, AL, July 1992.

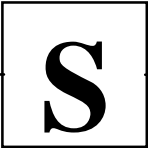

Sample Showing How to Handle a Table Continued to the Next Page

Table 15. Correlation coefficient (r) between chemically extracted elements from Alabama top soil and elements accumulated by each aquatic plant.

Extractants	Correlated Parameters for Plant and Soil	Alabama top soil and elements accumulated by each aquatic plant.			
		Cattail	Maidencane	Pickerelweed	Bulrush
Mehlich 3	Zn	-0.05	-0.68	-0.76	-0.95
	Pb	~	~	~	~
	Cd	~	~	~	~
	Ni	~	~	~	~
	Fe	-0.76	0.34	0.58	0.18
	Mn	0.81	-0.92	-0.80	-0.51
	Mg	-0.55	0.99**	0.97*	0.58
	Cu	~	~	~	~
	Cr	~	~	~	~
	Ca	0.93	-0.84	-0.69	-0.22
	Na	0.31	-0.86	-0.17	-0.21
	K	-0.39	-0.98*	0.38	-1.00**
DTPA	Zn	0.44	-0.97*	~	~
	Pb	~	~	~	~
	Cd	~	~	~	~
	Ni	~	~	~	~
	Fe	-0.81	-0.83	~	~
	Mn	0.38	-0.99**	~	~
	Mg	0.45	0.61	~	~
	Cu	-0.87	-0.94	~	~
	Cr	~	~	~	~
	Ca	~	~	~	~
	Na	-0.61	0.98*	~	~
	K	0.94	0.51	~	~

*, ** Significant at the 0.01 and 0.05 probability levels.
~Elements undetectable in spoils/soil materials.

These pages (shown at 50% of normal size) illustrates how to handle a table which continues onto the next page. Notice that on the second page, the table number is repeated again with *continued* in parenthesis immediately after it and the same column headings are carried over.

Table 15 (continued)

Extractants	Correlated Parameters for Plant and Soil	Alabama top soil and elements accumulated by each aquatic plant.			
		Cattail	Maidencane	Pickerelweed	Bulrush
0.1N HCl	Zn	0.44	-0.97*	-0.94	-0.21
	Pb	-0.19	-0.19	0.24	0.64
	Cd	~	~	~	~
	Ni	~	~	~	~
	Fe	-0.99**	-0.22	0.06	-0.38
	Mn	-0.99**	0.40	0.18	-0.21
	Mg	0.01	0.90	0.95*	0.94
	Cu	-0.87	-0.76	-0.76	-0.94
	Cr	0.50	-0.21	-0.82	-0.76
	Ca	0.24	-0.93	-0.99**	-0.92
	Na	0.76	-1.00**	0.37	-0.69
	K	0.59	-0.68	0.99**	-0.45

*, ** Significant at the 0.01 and 0.05 probability levels.
~Elements undetectable in spoils/soil materials.

Adapted from source: Constance Rochelle Buford, "Growth Evaluation of Four Aquatic Plant Species on Flooded Strip mine Spoil Materials." Master of Science Thesis, Department of Plant and Soil Science, Alabama A&M University, Normal, AL, April 1995.

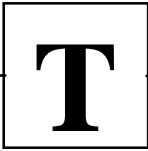

Technique for Folding Oversized Pages in the Thesis or Dissertation

This page shows the dimensions of oversized pages and how to fold them to achieve a single-fold or double-fold page in your thesis or dissertation.

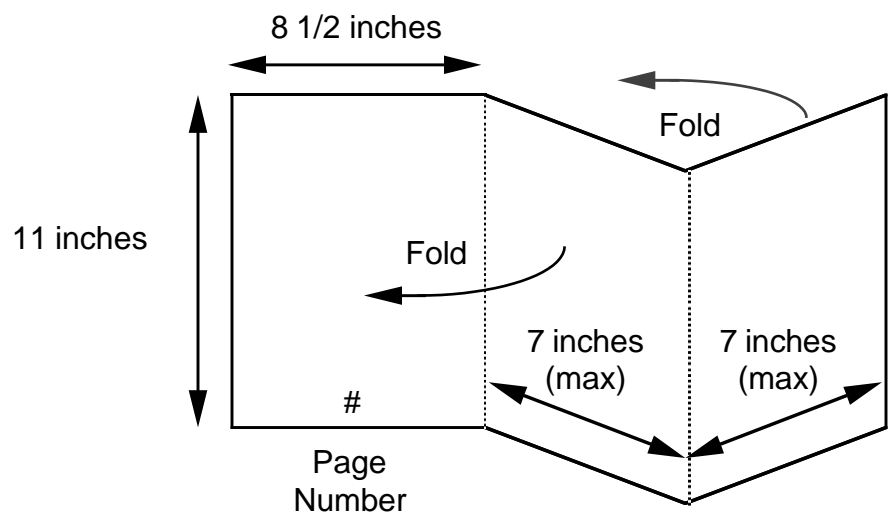
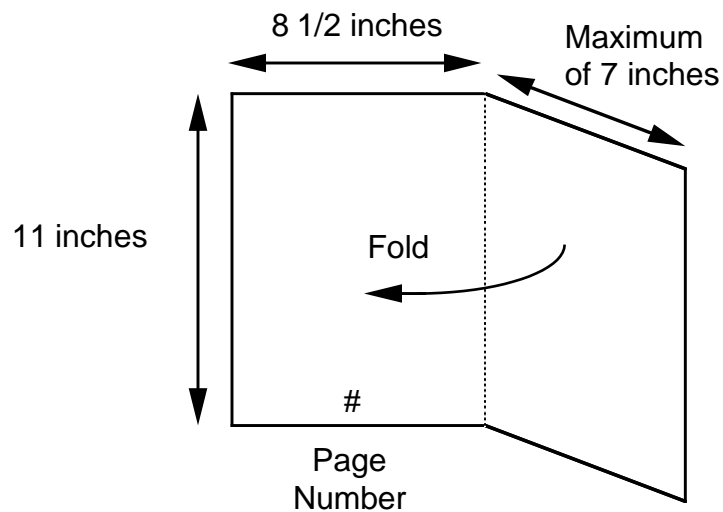

U

Sample Figure with Subtending Caption

This page (shown at 60% of normal size) illustrates the format to be used for a figure which fits on one page easily and the placement of the figure number and caption.

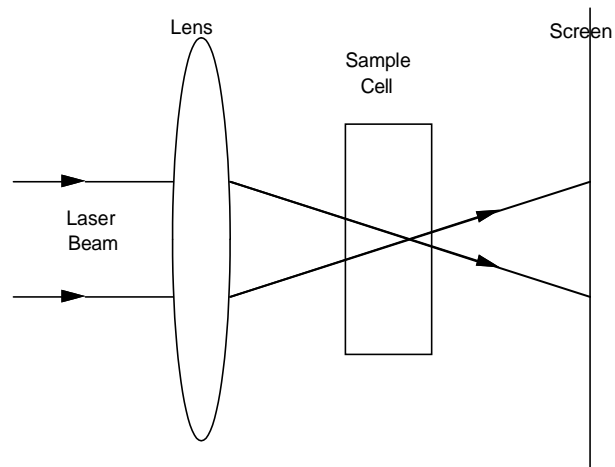
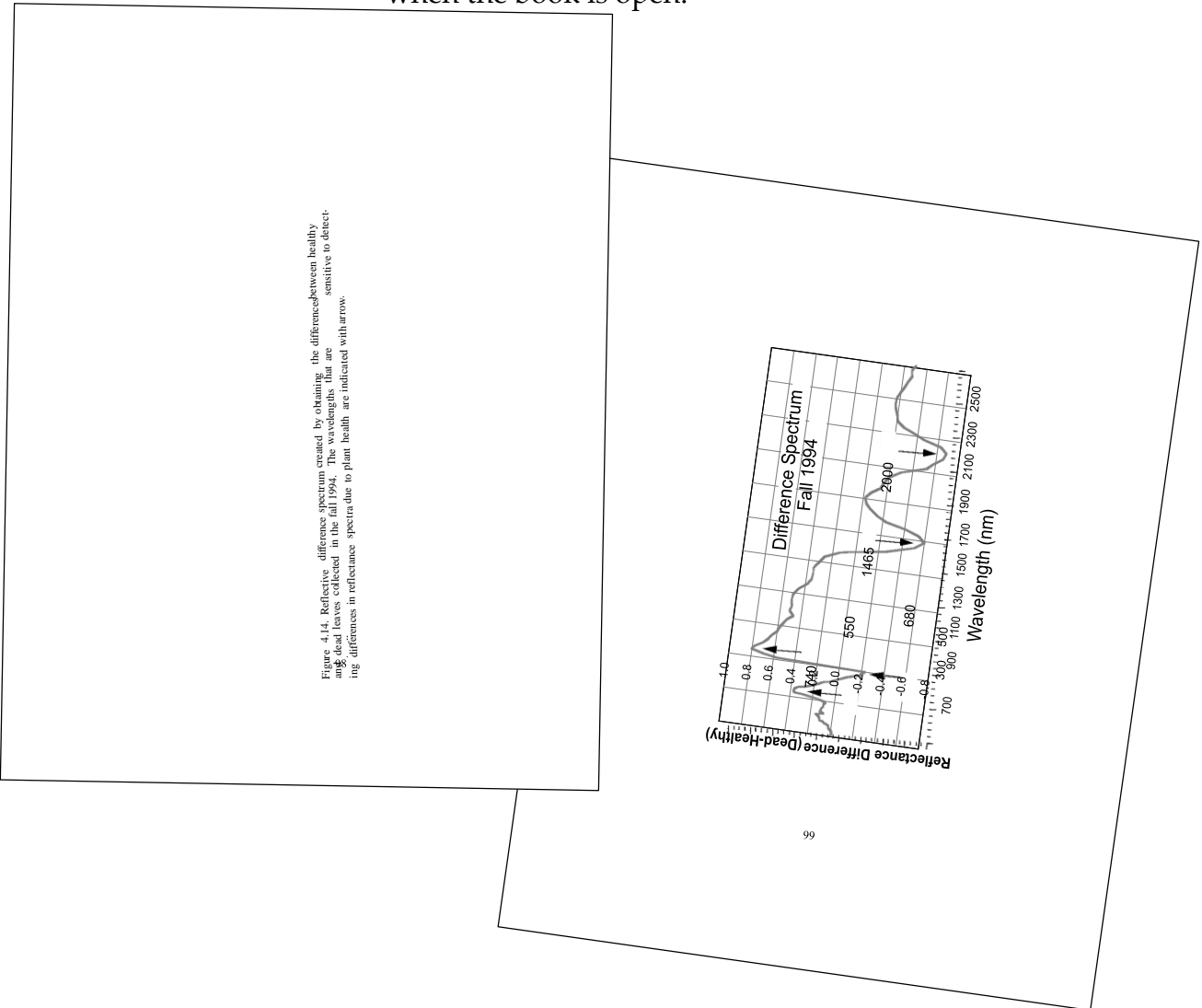

Figure 3.9. Schematic of the self-trapping setup

Source: Angela Shields, "Nonlinear Optical Characterization of Benzil." Master of Science Thesis, Department of Physics, Alabama A&M University, Normal, AL, November 1993.

Sample Horizontal Figure with Opposing Caption Page

These pages (shown at 40% of normal size) illustrate how to handle a figure whose orientation requires horizontal placement. Note that the bottom of the figure faces the outside edge, the orientation of the figure number and caption are also oriented horizontally, and that the page number is located in the usual position at the bottom of the page. The page containing the caption should be located facing the figure so that both are visible at the same time when the book is open.



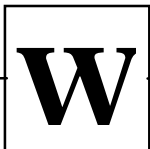

Sample Page Showing Figure Integrated into the Text

This page (shown at 60% of normal size) illustrates the format to be used for integrating figures into the text. This method is used only for small figures which constitute less than one half of the page in length.

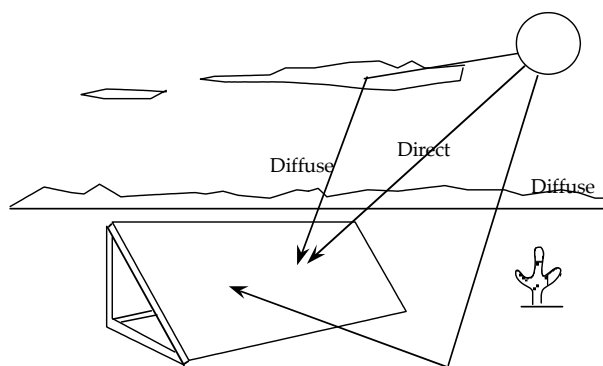

Figure 1.9. Distinction between direct and diffuse radiation.

The difference between direct and diffuse sunlight is important in one sense. Many of the existing concentration PV systems simply cannot use diffuse light. Most conventional optical equipment such as lenses can carry out their concentration function only when the light comes in at normal incidence to the surface of the lenses. If light is not normally incident (or is diffuse), then these lenses simply cannot focus the light in the direction and distance desired. See Figure 1.9.

Furthermore, diffuse light occupies a sizable portion of the total (or global) sunlight, reaching anywhere between 20% to 60% at different regions of the earth. Hence a PV design made with circumspection should never overlook the need to successfully tap into diffuse radiation. Holograms are devices that possess some angular tolerance; i.e. they can use diffuse radiation to a certain

Source: William Sheng-Te Tang, "The Investigation of a Cost-Conscious Holographic Solar Concentrator." Master of Science Thesis, Department of Physics, Alabama A&M University, Normal, AL, May 1995.

Sample Appendix Page for the Thesis or Dissertation

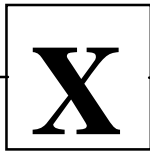

This page (shown at 60% of normal size) illustrates a typical appendix at the end of a thesis or dissertation.

Appendix A.3

NOTED WEED INVASION, ALGAE, OTHER VEGETATION, AND WILDLIFE

The three most common weed invaders were fall panicum (*Panicum dichotomiflorum*), barnyardgrass (*Echinochloa crusgalli*), and yellow nutsedge (*Cyperus esculentus*). The fall panicum and barnyardgrass persisted after the cells were flooded. Competition from these invading grasses at the shallow end of the cells was probably responsible for some wetland plant loss on the Alabama spoil and topsoil. Also, algae blooms and other vegetation were most prevalent in the same soils. Birds and frogs were seen.

65

Source: Constance Rochelle "Growth Evaluation of Four Aquatic Plant Species on Flooded Strip Mine Spoil Materials." Master of Science Thesis, Department of Plant and Soil Science, Alabama A&M University, Normal, AL, April 1995.

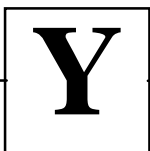

Sample Bibliography Page for the Thesis or Dissertation

This page (shown at 60% of normal size) illustrates the format for preparing the bibliography or list of references section at the end of the thesis or dissertation. Once an appropriate style has been chosen, be consistent in its use.

Note that the references are single-spaced within each entry but double-spaced in between entries.

BIBLIOGRAPHY

- AACC. 1983. Approved Methods of AACC. American Association of Cereal Chemists. St. Paul, MN.
- Baker, B. A., Davis, E. A. and Gordon, J. 1990a. Glass and metal pans for use with microwave and conventionally heated cakes. *Cereal Chem.* 67(5):448-451.
- Baker, B. A., Davis, E. A. and Gordon, J. 1990b. The influence of sugar and emulsifier type during microwave and conventional heating of a lean formula cake batter. *Cereal Chem.* 67(5):451-455.
- Bale, R. and Muller, H. G. 1970. Application of the statistical theory of rubber elasticity to the effect of heat on wheat gluten. *J. Food Technol.* 5:295-300.
- Bell, D. A. and Steinke, L. W. 1991. Evaluating structure and texture effects of methylcellulose gums in microwave-baked cakes. *Cereal Food World* 36(11):941-944.
- Bernardin, J. E. 1978. Gluten protein interaction with small molecules and ions - the control of flour properties. *Bakers' Digest* 52(4):20-23.
- Biliaderis, C. G. 1992. Structures and phase transitions of starch in food systems. *Food Technol.* 46(6):98-109.
- Biliaderis, C. G. and Tonogai, J. R. 1991. Influence of lipids on the thermal and mechanical properties of concentrated starch gels. *J. Agric. Food Chem.* 39:833-840.
- Bloksma, A. H. 1990a. Rheology of the bread making process. *Cereal Foods World* 35(2):228-236.
- Bloksma, A. H. 1990b. Dough structure, dough rheology and baking quality. *Cereal Foods World* 35(2):237-244.

87

Source: Bin Pan, "Effect of Peanut Flour Supplementation on Textural and Rheological Changes of Wheat Dough during Microwave Baking." Master of Science Thesis, Department of Food Science and Animal Industries, Alabama A&M University, Normal, AL, July 1994.

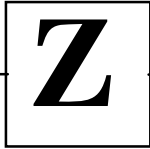

Sample Vita for the Thesis or Dissertation

This page (shown at 60% of normal size) illustrates a typical vita at the end of a thesis or dissertation.

The vita page is not numbered.

VITA

Tara H. Hayes, daughter of Robert Hayes and Betty (Moore) Hayes, was born February 28, 1969, Scott Air Force Base, East St. Louis, Illinois. In January 1988, she entered Alcorn State University, Lorman, Mississippi, and received the degree of Bachelor of Science in May 1992. She entered graduate school at Alabama A&M University, Normal, Alabama, in May 1992. She married Abram Dunbar III on December 28, 1994. Shortly after obtaining her M.S. in Plant Science at Alabama A&M University in May 1995, she began work toward a Ph.D. at the University of Missouri - Columbia.

Adapted from source: T.H. Hayes, "Use of Remote Sensing Techniques Coupled with Leaf Spectroscopic Methods to Evaluate the Severity of Dogwood Anthracnose in Native Stands of Alabama." Master of Science Thesis, Department of Plant and Soil Science, Alabama A&M University, Normal, AL, May, 1995.

Index

A

- Abstract 40
 - content 13
 - format of 14
 - length 13
- Advisory committee
 - outside member 3
 - selection of 3
 - submitting final draft to 8
- Appendices 22,57
 - content 21
 - format for 21
 - numbering of 14

B

- Bibliography 22, 58
 - acceptable styles 22
- Body of the thesis or dissertation 16

C

- Certificate of approval 13, 37
- Chapter or section headings 17
- Copyright page 13, 38
- Copyrighted material
 - use of 3

D

- Dedication 13
- Dedication page 39

E

- Endnotes 18
- Equations 48
 - format for using 18
 - numbering 18
- Ethical conduct 1, 24
 - of the graduate student 1, 24
 - of the graduate advisor or committee 25

F

- Figures
 - computer graphics 11,21
 - general guidelines 21
 - horizontal placement 19, 50
 - integrated into the text 19, 56
 - margins 19

- use of a facing page 51

- Final defense
 - awareness of professional setting 24
 - deadline for 8
 - parts of the defense 24
 - permission to hold 8
 - phase I 24
 - phase II 24
 - requesting a date for 8
 - role of the major professor 25
 - signature page 8
 - typical scenario for 25

Final draft

- deadline for submission 29
- submitting 9, 29

Fly page 12, 23

Folding oversized pages 53

Footnotes 18

Format

- beginning a chapter 17, 46
- margins 10
- subdivisions 13, 46

G

Grammar, punctuation, usage 33

I

Introduction

- content 15, 16
- format for 15, 16

K

Key words 13, 40

L

List of abbreviations 44

List of figures 43

- format for 15
- numbering of 15

List of plates 15, 21

List of references 5, 22

- acceptable styles 22

List of symbols, abbreviations, nomenclature 44

List of tables 15, 42

M

- Major
 - professor selection of 3
 - conduct during the defense 24
- Margins 10
 - justified 10
 - right-ragged 10
- Milestone charts 34

N

- Numbering
 - appendices 22, 57
 - figures 11
 - tables 11

O

- Oral defense 8, 31
 - signature page 8, 31, 35
- Oversized pages 53

P

- Pagination
 - body of thesis 11
 - fly pages 12
 - preceding pages 12
- Paper
 - type required 9
- Photographs 19
- Plagiarism 1
- Printing
 - types of printers 10
- Proposal 3
 - due date 3, 23
 - submission to the Graduate Office 3
 - not in the semester of graduation 3

R

- References 22
- Research proposal
 - due date 3
 - introduction 4
 - list of references 5, 58
 - literature review 4
 - methodology 5
 - milestone chart 34
 - objectives 4
 - parts of 4

- statement of the problem 4
- submission to the Graduate Office 3

S

- Selecting your advisory committee 3
- Selecting your major professor 3
- Signature page 8, 31, 35
- Spacing
 - double-space 9
 - single space for quotations 9
- Spelling 33
- Style manuals and guides 1, 6, 33
- Subdivisions
 - first order 17
 - format for 16
 - second order 18
 - third order 18
- Submitting
 - final draft 9, 29
 - single space for reference 9
 - single space for tables 9

T

- Table of contents 14
- Tables 19
 - continuation to other pages 19, 48
 - format for 19
 - horizontal placement 19, 50
 - integrated into the text 19, 51
 - numbering of 11
 - placement in pockets 20
 - use of a facing page 19, 46
 - vertical placement 19, 49
- Tabs 10
- The Graduate School
 - submission of final draft 3
- Thesis or Dissertation
 - as a series of journal articles 22
 - binding 10
 - counting the pages of the 11
 - deposit of final copy 9
 - final copy paper 9
 - photocopying 9
 - format 9
 - number of copies required 8
 - numbering or order of the 11
 - parts of the 11
 - subdivision of 17, 18
- Timetable charts 34

Title page 12, 36
Typing the thesis or dissertation
 typestyle 9, 10

W

Widows 10
Word processors 9
 font style 9, 10